

EVO NEST

QUICK GUIDE

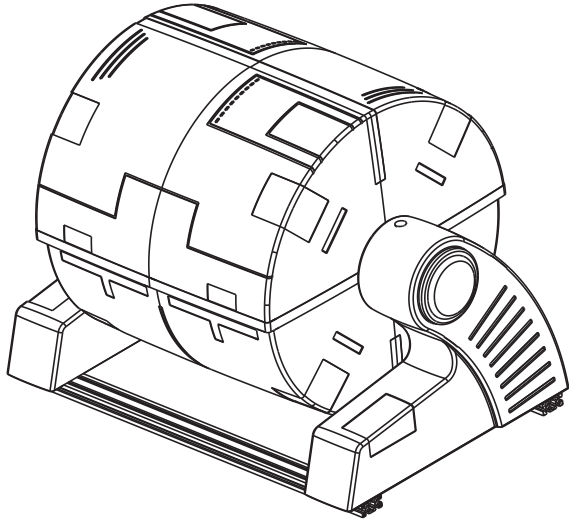









1. DISCLAIMER

To ensure safe and successful operation of your EVO NEST, please strictly follow the operating instructions and steps in this guide.

If the user does not abide by the safety operation instructions, Autel Robotics will not be responsible for any product damage or loss in use, whether direct or indirect, legal, special, accident or economic loss (including but not limited to loss of profit) and does not provide warranty service. Do not use incompatible parts or any method that does not comply with the official instructions of Autel Robotics to modify the product.

2. ITEM LIST

DIAGRAM	ITEM NAME	QTY
	Charging Board	1
	Canopy	1
	Charging Pedestal	1
	Waterproof Connector	1
	Power Cable	1
	Aircraft Battery	2
	Hex wrench	1
	Quick Guide	1

3. INTRODUCTION

EVO NEST is an automatic drone charging station that enables industrial drones to land, takeoff, and carry out consecutive missions with no human intervention. Equipped with a retractable canopy, a glass-fiber charging board, and a built-in air conditioning system, the NEST has everything it needs to keep itself and its aircrafts in great working condition, no matter the weather. Using exclusive software, operators can also plan flight tasks from the comfort of their home office, reducing labor costs while enhancing efficiency.

4. PREPARATIONS

1. Check the appearance of the product

- Check the canopy to make sure there is no damage caused by transportation or movement.
- Check whether the canopy is well sealed to ensure that it will work normally in a dusty or humid environment.
- Check the flatness of the charging board and the cleanliness of the position bar to ensure that charging can be carried out normally.

Note: If you find any problems, please contact the official support service of Autel Robotics at (844) 692-8835.

2. Pedestal installation

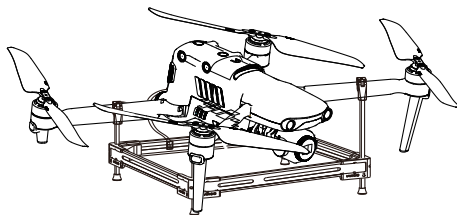

1. The charging pedestal has 4 arm fixing clips. The two shorter fixing clips are marked with E, and the higher fixing clip is marked with F. The E fixing clip is used to fix the rear arm, and the F fixing clip is used to fix the front arm.

2. After fixing the arm, install the battery to the drone, and connect the cable under the battery to the pedestal.

3. Site selection

1. Please choose an open area, such as empty ground, roof, etc.
2. Please choose a place with good GPS signal (at least 10 bars) and weak electromagnetic interference. You can use the drone to test the GPS signal and electromagnetic environment before selecting the site.

4. Product connection

1. Plug in the power cable, and then connect the network cable to the RJ45 port.
2. Press the power button on the EVO NEST to turn it on.

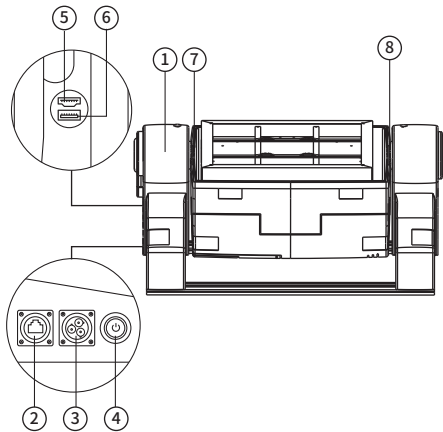

- | | |
|---------------------------|---------------------------------|
| 1-Remote control base | 5-HDMI to SBC interface |
| 2-RJ45 network cable port | 6-USB to SBC interface port |
| 3-Power interface | 7-LED charging status indicator |
| 4-Power button | 8-Surveillance cameras |

Note:

- Please remove the side cover with a hex wrench before connecting to the USB or HDMI interface.
- When the EVO NEST is energized, do not lean or press on the canopy, otherwise the position of the motor sensor will be changed and the rain cover will not be closed tightly.
- As the canopy is not pressure resistant, if the position of the cover changes, please call Autel Robotics' support team for technical assistance. Do not make any changes without direction from a representative of Autel Robotics.
- For your safety, please use a three-phase power plug.

5. Pre-flight Confirmation

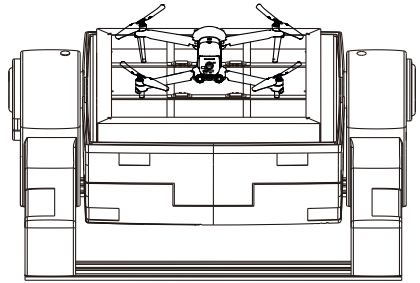

1. Make sure that the drone is placed in the center of the charging board.
2. Check carefully whether the connection of the power supply and the network is correct.
3. Confirm that no one is 2 meters near EVO NEST.

5. USE OF EVO NEST

1. Get your account

Please contact Autel Robotics to obtain the account and password of Autel SkyCommand Center.

2. Login

Log in to the Autel SkyCommand Center and use the system.

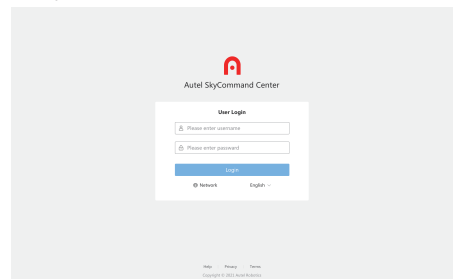

3. Using software

Please visit <https://www.autelrobotics.com/> and refer to the software manual for control.

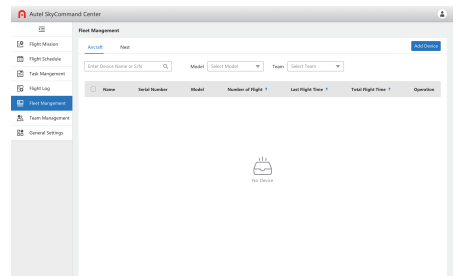

6. CAUTIONS

1、 How to ensure precise landing

(1) Before flying the drone, please make sure that the GPS signal is not less than 15 bars.

(2) If the GPS signal does not meet the requirements, please find an open space to place the EVO NEST, and then test at least 10 flights, landing drones after marking the take-off point to ensure that the average moving distance between the landing point and the take-off point is within 10 cm.

2、 How to ensure a smooth control experience

To get a smooth real-time monitoring experience, you need to ensure a relatively high and stable network speed and avoid delays caused by multiple users accessing the same network.

3、 Check the canopy after each flight

If the canopy fails to close automatically after the flight, please call Autel Robotics' support team. You can also log in to the software to close the canopy.

Note: If you encounter rain while the cover is not closed, please unplug the power cord and internet cable immediately. Dry the interface and the drone, and do not fly again until both the interface and drone are completely dry.

7. MAINTENANCE

1、 Power interface

Please check the interface of the power cable regularly to avoid damage and prevent water leakage. If the above situation occurs, please call Autel Robotics' support team.

2、 Charging board

The screw rod needs to be cleaned with lubricating paste every two months to prevent rust.

3、 Air conditioning

Please check the air conditioner every three months to make sure it is operating properly. After severe weather, special inspections need to be carried out in time.

4、 Pedestal

If you need to replace the pedestal, please use the pedestal provided by Autel Robotics.

5、 Control module

If you need a charging control module or a position bar control module, please use the replacement module provided by Autel Robotics.

8. APP AND FIRMWARE UPGRADE

Please follow the steps below to upgrade the App and firmware of EVO NEST.

1、 App upgrade

1. Prepare a monitor, an HDMI cable, a mouse and a USB docking station.
2. Connect the docking station to the USB port on the EVO NEST, plug the mouse cable into the docking station, and connect one end of the HDMI cable to the monitor and the other end to the HDMI port on the EVO NEST.
3. Open the browser and visit the official website of Autel Robotics to download the latest version of the upgrade package of the App.

2、 Firmware upgrade

1. Prepare a monitor, an HDMI cable, a mouse and a USB docking station.
2. Connect the docking station to the USB port on the EVO NEST, plug the mouse cable into the docking station, and connect one end of the HDMI cable to the monitor and the other end to the HDMI port on the EVO NEST.
3. Open the browser and visit the official website of Autel Robotics to download the latest version of the upgrade package of firmwares.

9. SPECIFICATIONS

Size (LxWxH)	closed: 43.86 x 28.86 x 28.86 in (1114 x 733 x 733 mm) opened: 43.86 x 28.86 x 20.24 in (1114 x 733 x 514 mm)
Protection	≥ IP54, rainproof, light resistant, corrosion resistant
Working temp.	-4~122°F (-20~50°C)
Weight	88.2 lbs (40 kg)
Humidity	30%~50%RH
Fatigue test	≥ 50000 times
Working power	Avg. 400 W
Working voltage	110V, 220V
Max. charging current	10 A
Charge time	45 mins